

This is new in Plant Design 2024

Version 2024 of Smap3D Plant Design contains many enhancements and improvements in functionality and application.

The most important ones are described below.

The different chapters in this document are:

- [General news](#)
- [New in P&ID](#)
- [New in the Coordinate System Wizard](#)
- [New in 3D Piping](#)
- [New in Isometric](#)

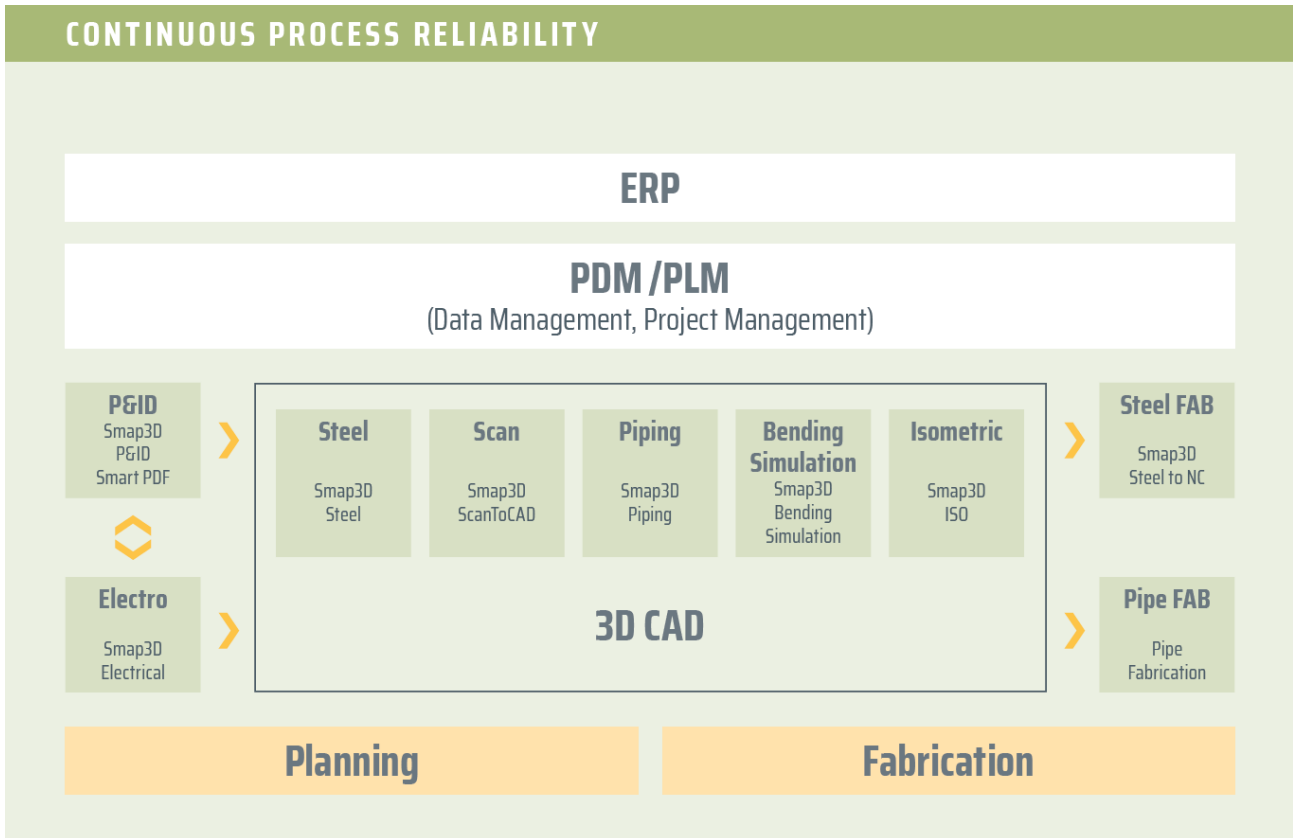

Table of Contents

GENERAL IMPROVEMENTS	3
SUPPORTED CAD VERSIONS	3
LICENSING REQUIRED IN VERSION 2024	4
NEW PRODUCT LICENSES REQUIRED FOR VERSION 2024	4
NEW SUB FOLDER "CUSTOMCONFIG" IN THE SMAP3D CONFIGURATION FOLDER.....	5
PARTS MANAGEMENT ADMINISTRATOR - NEW OPTION "RESTART CAD AFTER XX FILES".....	7
NEW IN SMAP3D P&ID	8
ENHANCEMENTS IN THE MODULES EDIT SYMBOLS/LINE DATA FIELDS.....	8
NEW IN THE "PIPELINE LIST" MODULE.....	9
NEW OPTION "SHOW HEADERS" WHEN SELECTING PIPE SPECIFICATION AND SIZE FOR LINES.....	12
NEW OPTION "MIRROR DOUBLE LINE"	13
SEPARATE TEXT FORMAT SETTINGS FOR VISIBLE TEXTS FOR SYMBOL DATA FIELDS AND LINE DATA FIELDS	14
NEW OPTION "INCLUDE ACCESSORIES" WHEN INSERTING COPIED SYMBOLS.....	15
EXTENDED REFERENCE FORMAT FOR LINE LINK REFERENCE	16
NEW IN THE COORDINATE SYSTEM WIZARD	17
NEW OPTION "HIDE CREATED COORDINATE SYSTEMS"	17
NEW IN SMAP3D PIPING	18
NEW FUNCTION CALCULATE COMPONENTS ROTATION	18
NEW FUNCTIONS FOR AUTOMATED ADAPTION OF ORBITAL WELDING COMPONENTS	22
ENHANCEMENT IN THE TRANSFER CONNECTION PROPERTIES FUNCTION	28
THE VC INFO WINDOWS IN THE WINDOWS OF THE PIPING AND P&ID TO-DO LIST APPLICATION REMEMBER THE LAST STATE	30
NEW IN SMAP3D ISOMETRIC	31
NEW SUB-OPTION "BRANCHING FITTINGS ON BOTH DRAWINGS"	31
IMPRINT	32

General improvements

Supported CAD versions

Solid Edge

The release version of Smap3D Plant Design 2024 supports:

- **Solid Edge 2023 with Maintenance Pack 9 or later**
- **Solid Edge 2024 with Maintenance Pack 1 or later**

Licensing required in version 2024

With Smap3D Plant Design 2024, the CAD-Partner Licensing software (License Server Manager and License Client Manager) must also be installed in version 2024.

Existing **License server installations** of CAD-Partner Licensing (when using floating and/or multiple node-locked licenses) must **be updated to version 2024**.

For details, refer to the **Installation Guide (in chapter > Upgrade)**, included in the installation package of version 2024.

This **will upgrade** an existing installation of License Server Manager 2023 **to version 2024**.

The updated version number of License Server Manager 2024 will then be **9.24.0.14**.

The name of the associated service is then **CAD Partner License Server 2024**.

The associated **FlexNetPublisher** version will be **11.19.1.0**.

All local License Client Managers, along with the Smap3D applications, must be uninstalled before an installation of Plant Design 2024 for client computer can be performed.

New product licenses required for version 2024

The Plant Design 2024 applications can only work with licenses issued for version 2024.

For this reason, customers with a valid maintenance contract will receive a customer-specific mail with the download link of the new version 2024, as well as the associated **new customer-specific license file** (for the hardware ID known to us).

New sub folder "CustomConfig" in the Smapp3D configuration folder

With version 2024 there is a change regarding the structuring of the configuration files for the Smapp3D Plant Design applications.

Previously, all Smapp3D configuration files (the mandatory ones, but also the optional user-specific ones) had to be stored directly in the set path of the configuration folder, so that the various Smapp3D applications could access them and use them accordingly.

Due to the many user-specific configuration options available in the Smapp3D Plant Design solution, the number of user-specific configuration files that may be stored there has also increased. This repeatedly led to confusion and sometimes even unintentional deletion of such configuration files by the customer's administrators.

To separate the mandatory configuration files from the user specific ones, the new **CustomConfig** subfolder is introduced in the substructure of the Smapp3D configuration folder.

When installing Smapp3D Plant Design 2024 in **Default Configuration and Data** mode (during an initial installation), the setup will install and store all the default custom configuration files directly into this new subfolder.

When installing Smapp3D Plant Design 2024 in **Existing Configuration and Data** mode (during an upgrade), the setup moves all user-specific configuration files (which are known to our software) that are already in the set configuration folder to the new **CustomConfig** subfolder.

After a correct installation of version 2024, there should only be the four necessary configuration files in the configuration folder (see image).

All other user-specific configuration files should then be in the **CustomConfig** folder.

Examples of user-specific configuration files for our applications include:

- FinishAndSaveOptions.xml
- VirtualCharsWriterNames.txt
- CSInfoCustomItems.xml
- IsometricGlobalRules.xml
- and many more.

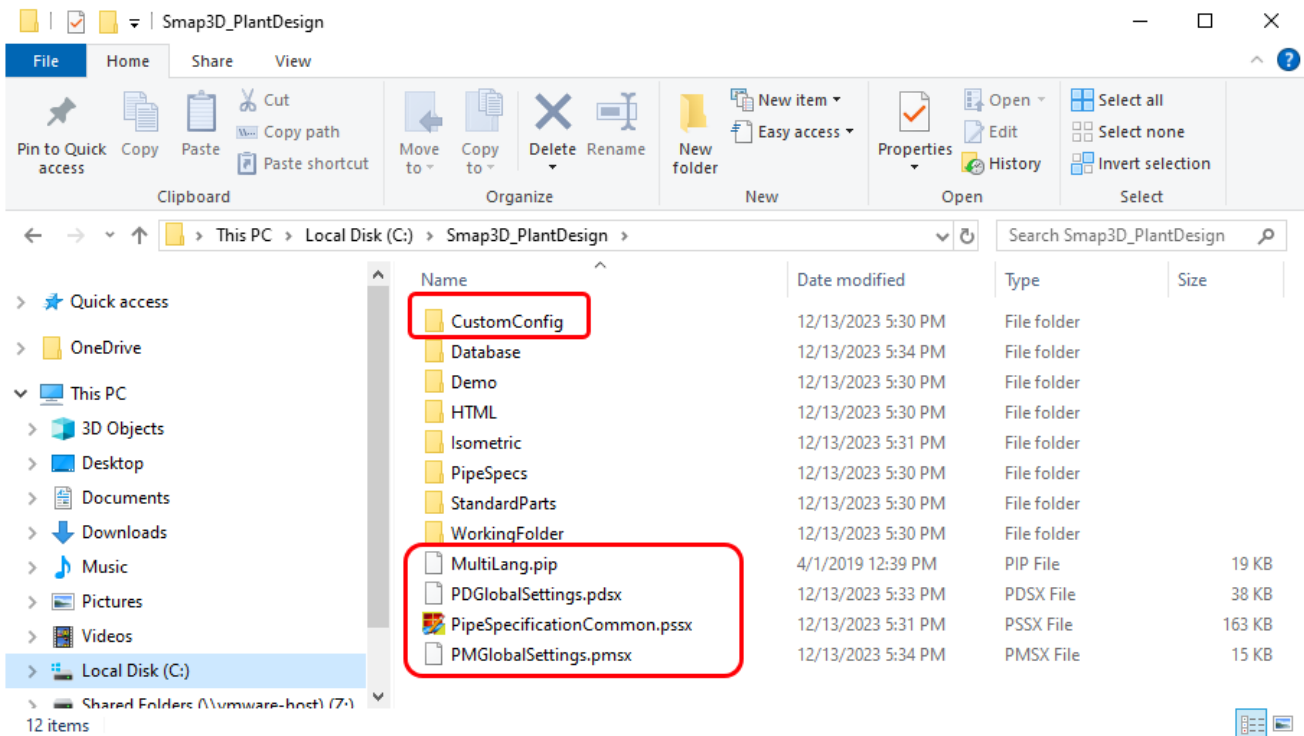

Parts Management Administrator - new option "Restart CAD after xx files"

The new **Restart CAD after xx files** option has been implemented in the Parts Management Administrator.

The option controls whether and, if active, at what interval, and automatic closing and restart of the 3D CAD system used should be carried out during the mass generation of Smmap3D standard parts.

Mass generation of standard parts is started, for example, with:

- the **Generate parts** function in the Pipe Specification Editor
- the **Generate category** or **Generate all categories** function in the Database Administrator

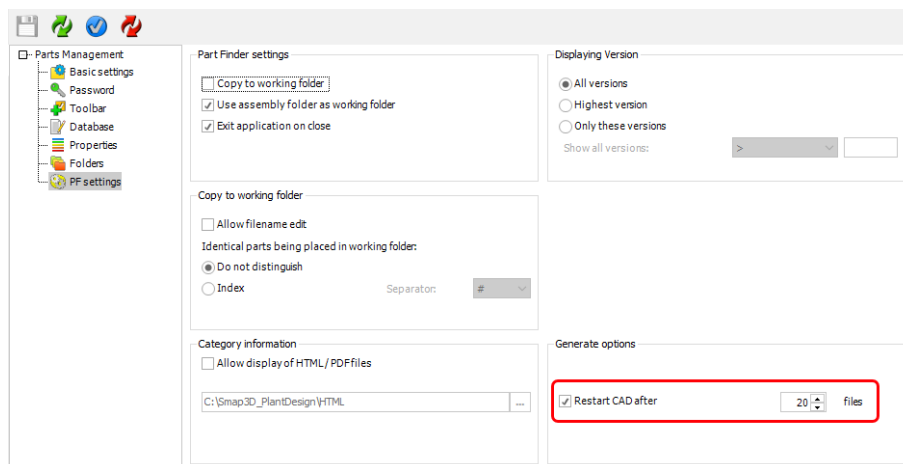

The reason for the development of this new option is a behavior of all 3D CAD systems we support when you call up the automatic creation/generation of 3D files from "outside" via the programming API of the 3D CAD systems.

In this case, the 3D CAD system uses a certain amount of main memory (RAM) on the respective computer with each generated 3D standard part file (even if it is immediately closed again), which is then unfortunately not immediately released again.

If you have hundreds or thousands of 3D standard parts automatically generated in one go, this can cause the computer in question to become very slow after a certain amount because the available RAM will eventually be full.

Only when the 3D CAD system is completely closed does this occupied RAM memory become available again.

Therefore, where necessary, you can now use this option to activate and set an automatic closing and restart of the 3D CAD system after a certain number of generated parts.

New in Smapp3D P&ID

Enhancements in the modules Edit symbols/line data fields

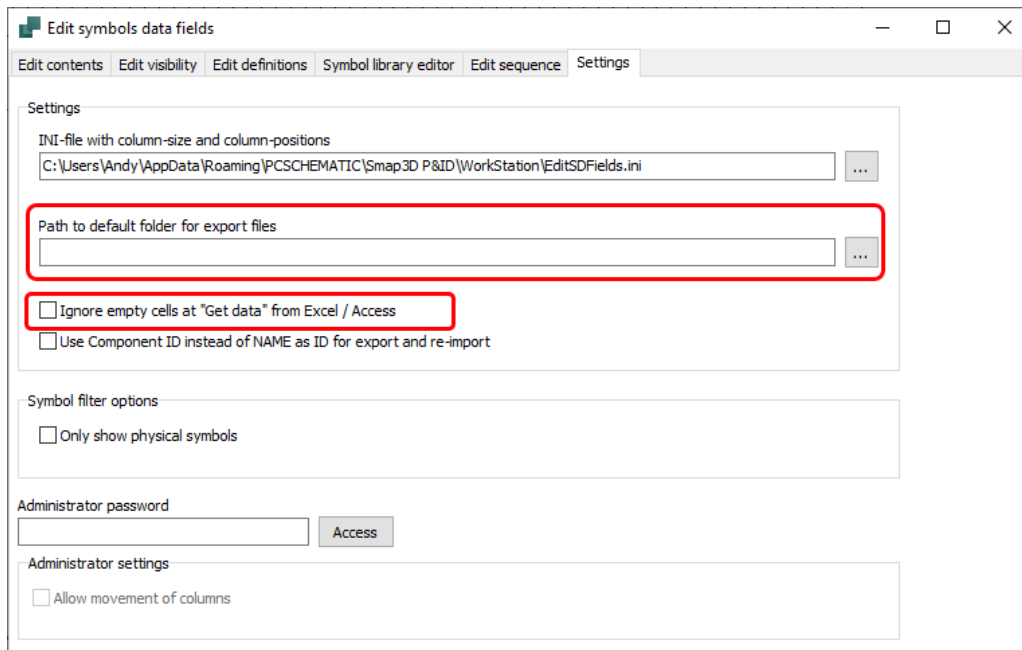

New setting "Path to default folder for export files"

This new option allows you to specifically define a directory path in which all exported files (Excel or Access format) from the **Edit symbols data fields** and **Edit lines data fields** tools are primarily saved.

Of course, a user can still individually select a different path during the export process if necessary.

New option "Ignore empty cells at Get Data from Excel/Access"

This new option controls the behavior when reimporting files (Excel or Access) that were previously exported from the respective tool.

If this option is not active (default setting), empty cells in the external files will be interpreted as values during the reimport and any values that may exist in the project and have been entered after the export, will be overwritten with an empty value.

If you want to prevent this from being overwritten with empty values/cells when importing external files back, this option must be activated.

New in the "Pipeline list" module

Improved evaluation algorithm for branch situations from line to line

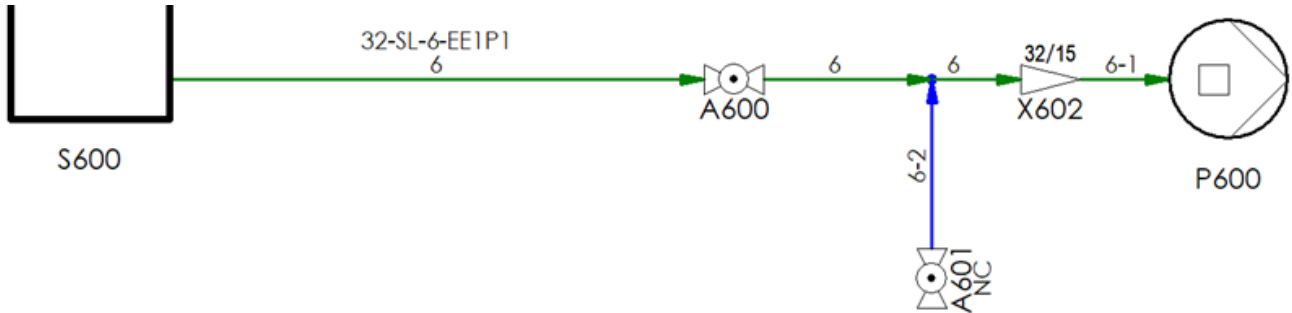

Some customers who have used the **Pipeline list** tool since its introduction in version 2023 have asked us over the past few months, to adjust the algorithm for the evaluation results. These requests applied to the cases of line-to-line branch situations in diagrams, in conjunction with the active **Exclude opposite flow** option.

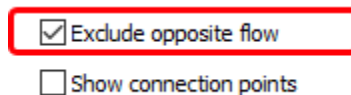

Until now, in the evaluation for such situations, the branch lines flowing in or out were often included in the result for the main line, even though using this option it is a flow in opposite direction.

We have now changed this in the algorithm and optimized it according to the rule definitions developed together with the customers.

New Export tab, with options for configuring the export results

Also at the customer's request, we have installed the **Export tab** in the Pipeline list tool.

This now included several new possibilities and options to further configure the result of the export to an Excel file.

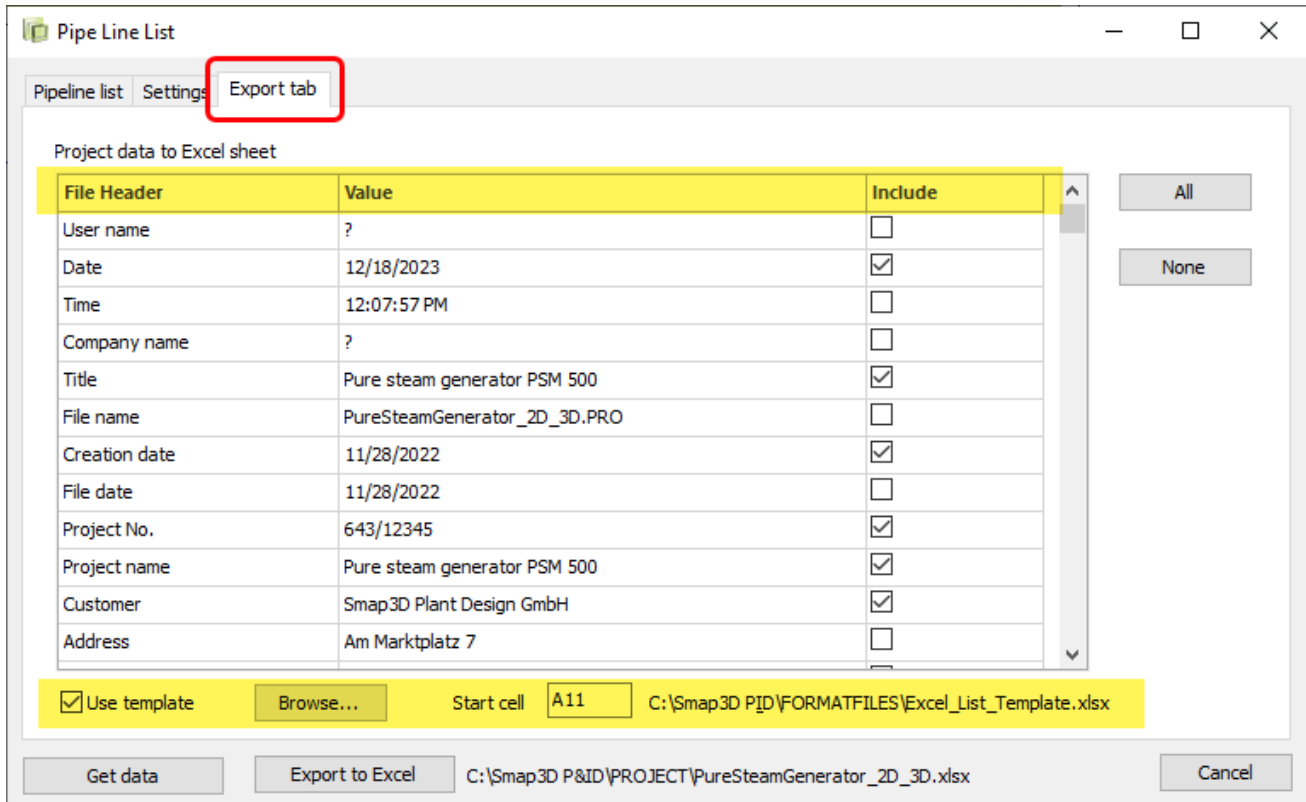

- In the **Project data to Excel sheet** area, after clicking on **Get data**, the project data available for the active project is listed.
 - By checking the box in the **Include** column, a user determines whether this information/row is output as a file header in the Excel spreadsheet.
 - Using the **All** and **None** buttons, a user can quickly make a general selection for the entire list.
- The **Use template** option (if activated) allows you to define an Excel template file, which can be selected using the **Browse** button.
 - Entering a **Start cell** defines the first (left) cell for exporting the information to the Excel spreadsheet.
 - The **path to a selected Excel template file** is displayed to the right of the start cell.

Using all the newly available options, exporting a pipeline list to an Excel file can look like the image.

11	Date	12/18/2023		
12	Title	Pure steam generator PSM 500		
13	Creation date	11/28/2022		
14	Project No.	643/12345		
15	Project name	Pure steam generator PSM 500		
16	Customer	Smap3D Plant Design GmbH		
17				
18	Line name	From	To	TAG
19	PL 100		W2001	PL 100 - 100 - CW - Spec10CA
20	PL 120	P2003		PL 120 - 100 - CW - Spec10CA
21	PL 230	P2002	F2001	PL 230 - 100 - HW - Spec10CA
22	PL 220	B2001;B2002	P2002	PL 220 - 100 - HW - Spec10CA
23	PL 110	W2001	P2003	PL 110 - 100 - CW - Spec10CA
24	PL 240	F2001	W2001	PL 240 - 100 - HW - Spec10CA

New option "Show headers" when selecting pipe specification and size for lines

Previously, when selecting pipe specification for selected lines in the P&ID, user could only use the pipe specification name, the diameter, and any additional characteristics to determine the correct pipe spec.

From P&ID 2024, users can also access the pipe specification header information available in the pipe specification files when making their selection.

Clicking on the new **Show headers** button (while a specification is selected) opens another window. This lists all pipe spec header information stored in the selected specification file with their name and value.

This additional pipe specification information is intended to help a user determine and select the required pipe spec more easily.

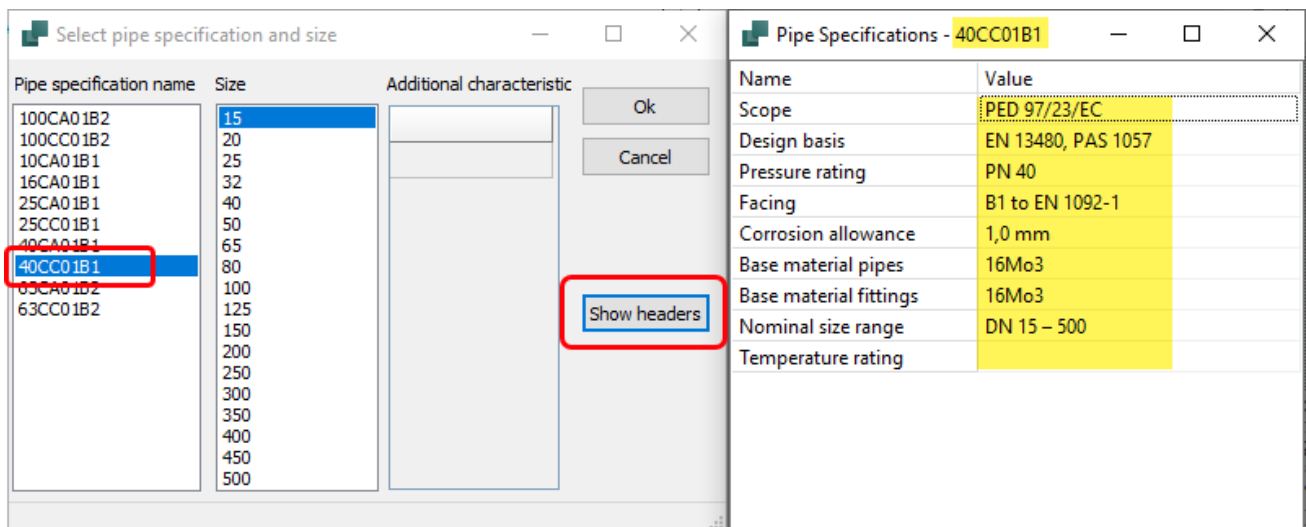

New option "Mirror double line"

For many versions there have been four different double lines in P&ID for a more specific representation of media flows in P&ID diagrams.

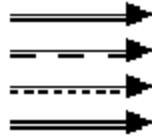

Since their introduction, these double lines have behaved according to fixed rules.

- For horizontal line segments, the secondary line is always displayed below the main line.
- For vertical line segments, the secondary line is always displayed to the right of the main line.

These rules remain valid for the initial creation of these four double line types.

New is the ability to individually influence the display of these four double lines after they have been created.

For this purpose, there is now the new **Mirror double line** function in the context menu for one or more previously selected double lines.

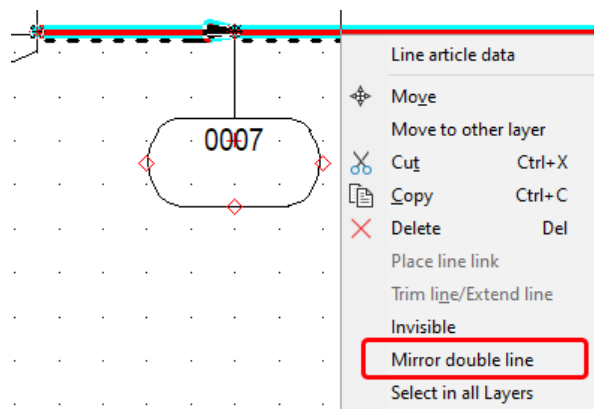

After clicking on this function, the representation of the secondary line (in relation to the main line) for the previously selected lines is mirrored according to the initial situation.

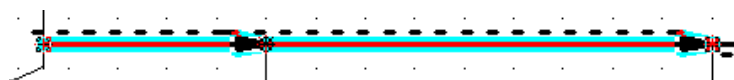

This means that users can now use these double lines more flexibly and individually according to their needs.

Separate text format settings for visible texts for symbol data fields and line data fields

In the general settings of Smapp3D P&ID, in the **Text/Symbol defaults** tab, separate text format settings are now available for visible texts of **Symbol data fields** and **Line data fields**.

Previously, users could only generally specify a default text format for data fields. This resulted in visible text from symbol and line data fields (controlled and transmitted by this settings) always being displayed in the diagram with an identical text format.

Following numerous customer requests, you can now easily and quickly set different text formats in these settings and transfer them to individual diagram pages or the entire project.

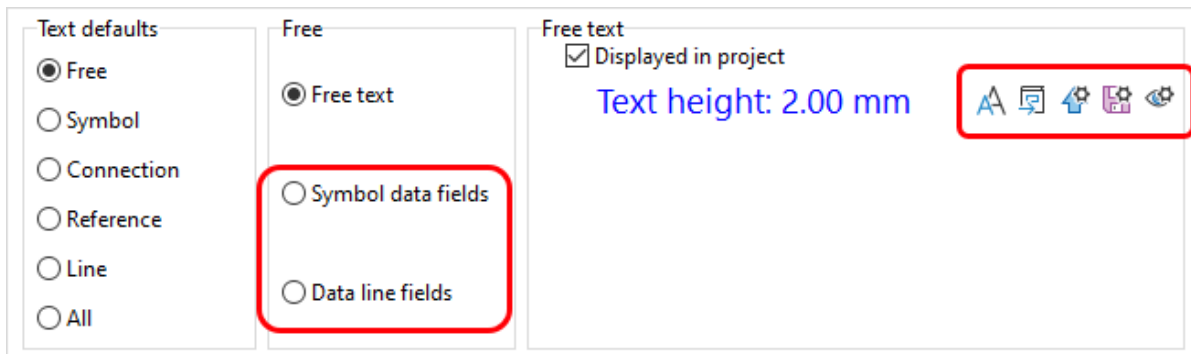

New Option "Include accessories" when inserting copied symbols

Users who work a lot with optional accessories for components had complained that these optional accessories were previously only transferred when copying and pasting (several symbols in one process) into other projects when using the **Rename Symbols** option.

With **Do NOT rename Symbols**, the optional accessories were automatically removed from the inserted components.

Count	Placed	Article	Type
Fixed accessories			
1	0	86901058	Motor
Optional accessories			
1	0	119002	Machine
1	0	2007	Equipment

To improve the previous behavior and unify it for users, the new general option **Include accessories** has been implemented.

This is now available for both options in the **Rename symbols** dialog and can be activated and used by the user as required.

- If this option is activated, existing optional accessories are always included.
- If this option is **not** activated, optional accessories will always be removed when inserted.

Rename Symbols ✕

Rename, if names already exist in the project

Do NOT rename Symbols
 Rename Symbols

Start No. (0=Next avail.):

Line Number

Include accessories

Do NOT show this dialog at next placement

Extended reference format for line link reference

To enable users to achieve the same results representing different types of objects, new bracket reference format representations have been added to the **Text/Symbol defaults** for the **Line link reference**.

Previously, only symbol references could be represented with brackets.

With P&ID 2024 we have unified this, and a bracket representation is now possible for both.

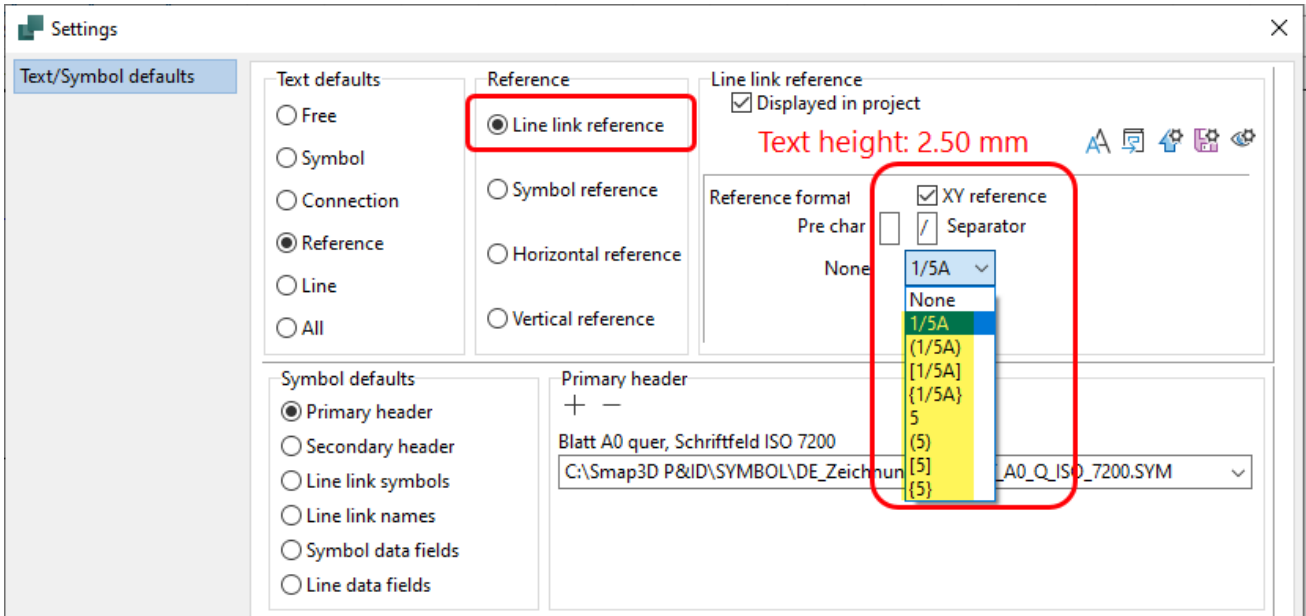

New in the Coordinate System Wizard

New option "Hide created coordinate systems"

Previously, the coordinate systems created with the Coordinate System Wizard were always visible as objects in the CAD work window after creation. If necessary, the user then had to subsequently and manually switch them to invisible/hidden in the feature tree.

To eliminate this additional effort for a user, we have added the new **Hide created coordinate systems** option to the Coordinate System Wizard.

If this option is active, the coordinate systems are visible during definition and modification, but are immediately set to invisible/hidden in the CAD work window after they have been created.

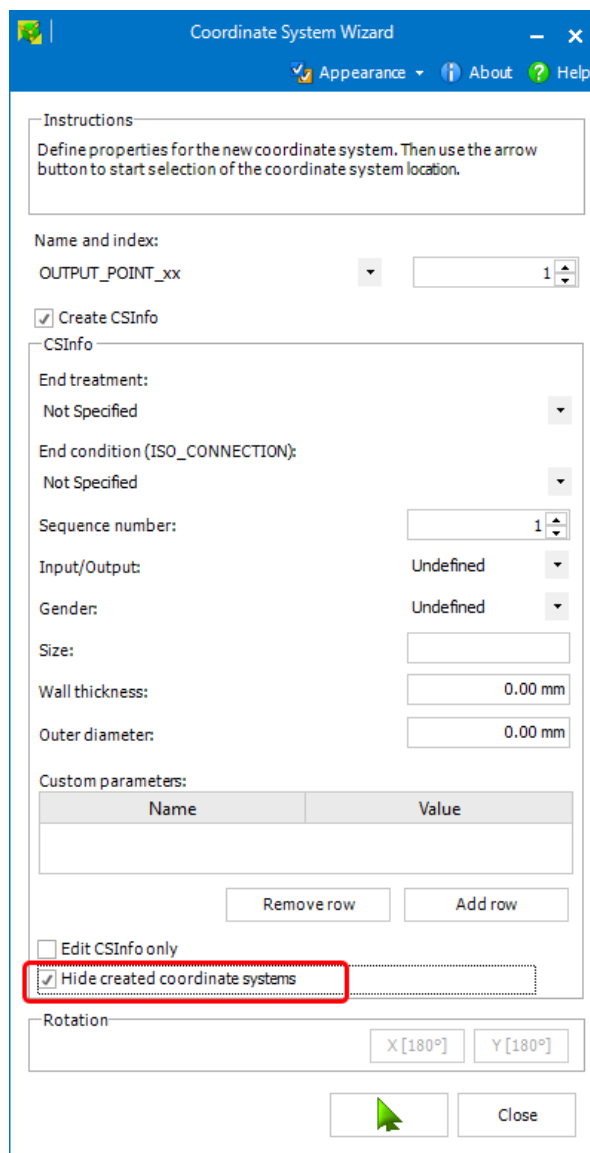

New in Smap3D Piping

New function Calculate components rotation

In the prefabrication/fabrication of pipelines (especially welded pipelines), it is important for an assembler/welder to know whether any rotation that may be present in the pipeline components must be considered when aligning the parts to one another (before welding them together). After welding pipelines, such rotational errors can only be corrected with a great deal of effort and expense.

The main pipeline components relevant to producing rotations are flanges, elbows or bent pipes, tees or collared pipes and eccentric reductions.

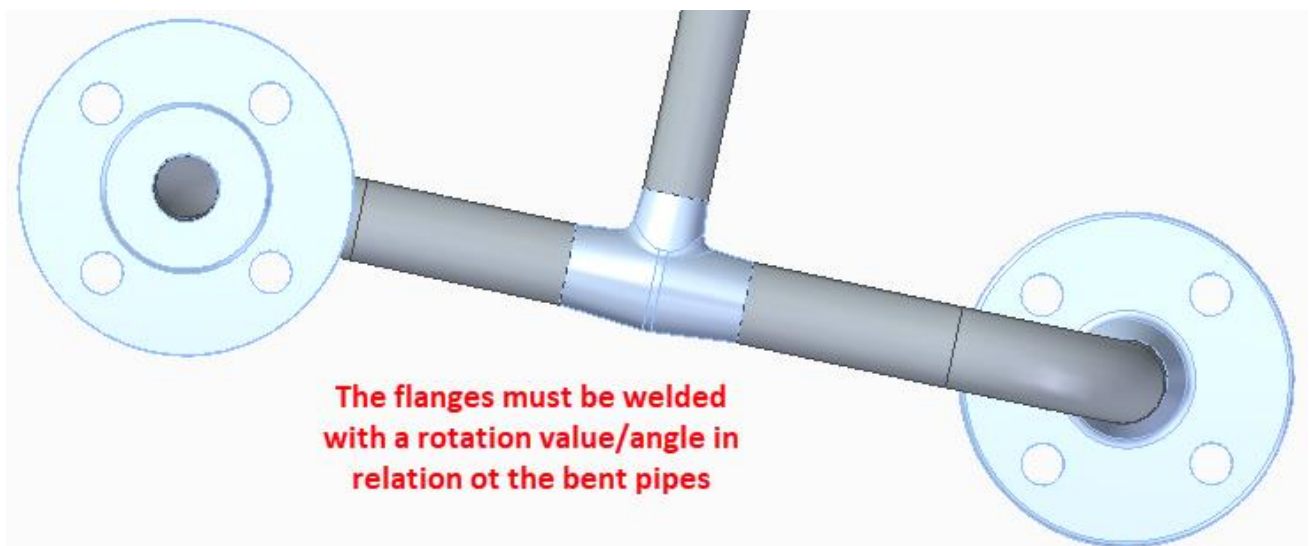

To better support our customers with this important manufacturing requirement during 3D pipeline planning, we have developed the new **Calculate component rotation** function for Smap3D Piping.

Where necessary, this function should only be executed for an active pipeline assembly as soon as NO fundamental changes are made to the pipeline route as well as the components placed on it and their orientations on the path.

This new function (if activated in the Plant Design Administrator) can be used and started by a user manually via the Piping **context menu** or the list field of **Refresh** function in the toolbar.

It is also possible to execute this function automatically as part of the configurable **Finish and save** function.

If use is NOT activated in the Plant Design Administrator, these buttons are not active (grayed out), and this calculation is not carried out even when you finish and save.

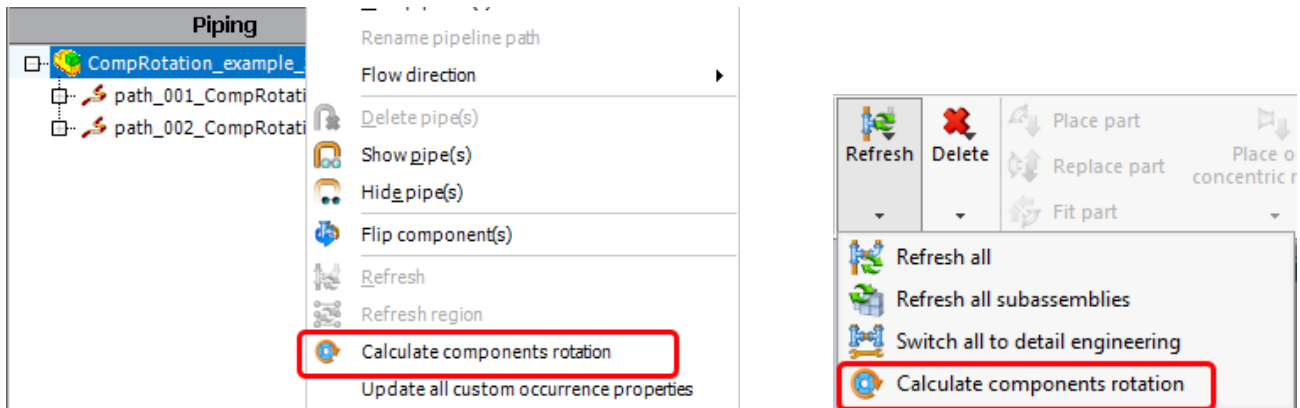

Immediately after starting, a **dialog with a progress bar** will be displayed. This will be closed automatically after the function ends.

Various analyzes and calculations then run automatically within the function:

- Determining the flow direction of a pipeline path.
- Determine the relevant components using your component vectors on a pipeline path.
- Vector mathematical calculation of the reference vectors and work planes along a pipeline path based on the flow direction and hierarchy/priority definition on the components.
 1. Eccentric reductions
 2. Working planes through bent pipes/elbows
 3. Working planes through branches
 4. First component of a pipeline path
- Vector mathematical calculation of the respective vectors/positions (scalar values) as well as the component rotation angle (in degrees).
 - A calculation is made for the reference vector, reference position vector, view vector, component vector, component position vector and component rotation angle.
 - The values for the view vector, reference vector, reference position vector and rotation angle are output.

The function writes the four values (**CR_View_direction**, **CR_Reference_vector**, **CR_Reference_position** and **CR_Rotation_angle**) to the parts as virtual characteristics.

These results become visible to a user as soon as a relevant component is selected in the piping structure tree after this function.

In the VC info window (as part of the Piping application window) the values calculated for the selected component are displayed as virtual characteristics.

The virtual characteristic **CR_Rotation_angle** contains the angle value of the rotation measured between the reference vector (in the reference component) and the component vector (in the selected component).

The resulting value is always an angle with a positive sign for a rotation of 0° to 180° clockwise to the reference vector, or with a negative sign for a rotation of 0° to -180° counterclockwise to the reference vector.

For flanges (if these are prepared accordingly), the algorithm can also take the number of holes into account, so that the calculated and written angle value corresponds to the **2-hole up rule** and can be used by the assembler/welder directly during fabrication according to this principle.

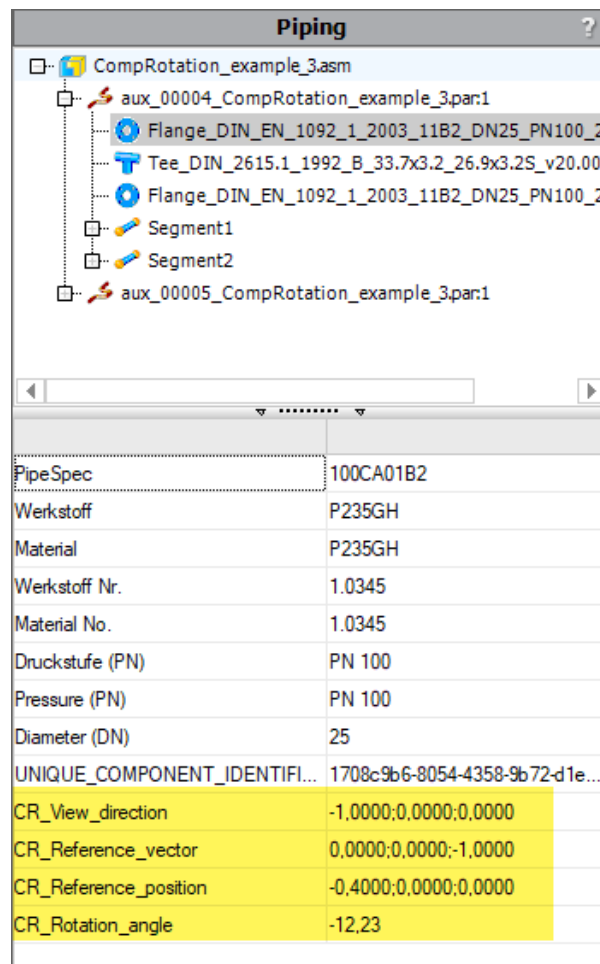

For this function and its included calculation algorithm to work correctly and determine correct values, certain requirements are of course necessary for the 3D models used in the pipeline.

We will be happy to provide you with detailed information on the requirements for the 3D models as well as all vector mathematical rules and priorities that apply to the function in an update training for version 2024 that you have booked with us, or in a specific consultation just for this function.

The rotation information calculated in Piping and written to the parts (as virtual characteristics) is then also available in the structure tree (step 2) of Smapp3D Isometric.

Using appropriate Isometric mappings and rules, you can bring the rotation angle or other information into Isogen and then visibly on the Isometric drawing.

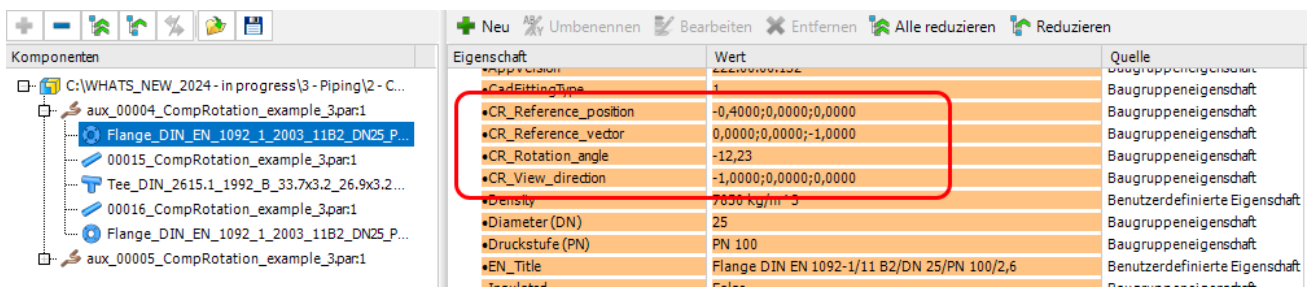

New functions for automated adaption of orbital welding components

In the food and pharmaceutical industries, great importance is placed on hygienic design using orbital welding components.

Pipelines must be designed in such a way, that they are easy to clean and ideally have no residual spaces in which contamination can remain.

To reduce residual spaces, commercially available orbital welding components are individually adapted depending on the installation situation to reduce the distances between the flat lengths on edges or in front of installations such as valves or sensors.

Previously, when working with Smap3D Piping, an individual adjustment of single 3D orbital welding components as well as all the associated steps for proper 3d file management had to be carried out individually and manually by the user, which took a lot of time.

To better support our customers for this industrial sector with these common pipeline planning tasks and reduce their efforts, we have developed new functions and automation specifically for the individual adaption of orbital welding components.

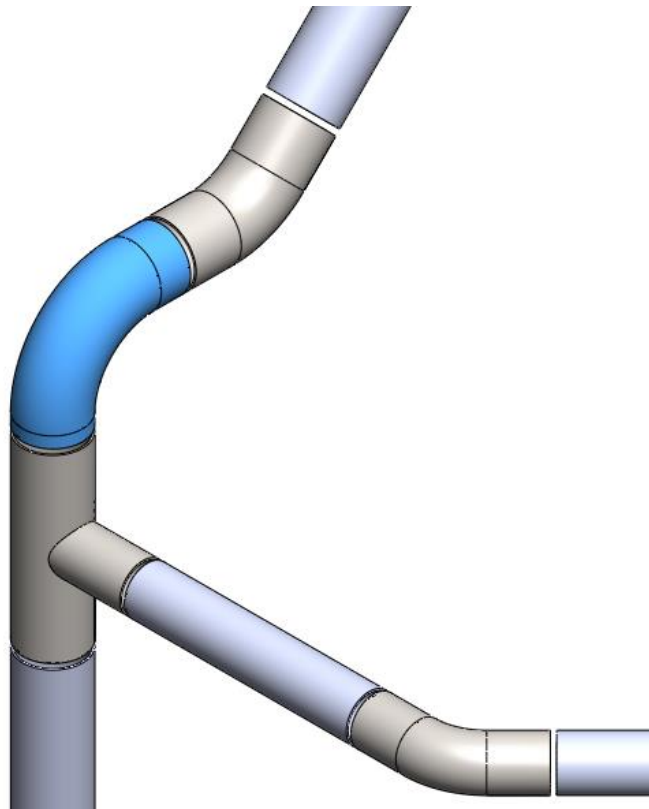

Basic requirements for using these new features

For these functions to be able to individually adapt each cylindrical end (leg/orbital cylinder) of such a 3D component depending on the installation situation, it is imperative that the 3D files are prepared/modeled accordingly for this purpose.

1. Each 3D component requires individually controllable parametric legs/orbital cylinders.
 - In each 3D file, the associated geometry (per leg/orbital cylinder) must be based on independent sketch elements.
 This means that each orbital cylinder must be individually controllable via dimensions and variables.
 - For each orbital cylinder in the 3D file there must be its own variable that controls the feature sketch and the dimension individually.
 - The names of these variables must have the naming and numbering **L1** for leg 1, **L2** for leg 2 etc.
 - The numbering and usage of the variables/equations (L1, L2 etc.) must correspond to the numbering of the Smapp3D coordinate systems for connection points (their SN parameter of the CSInfo property).

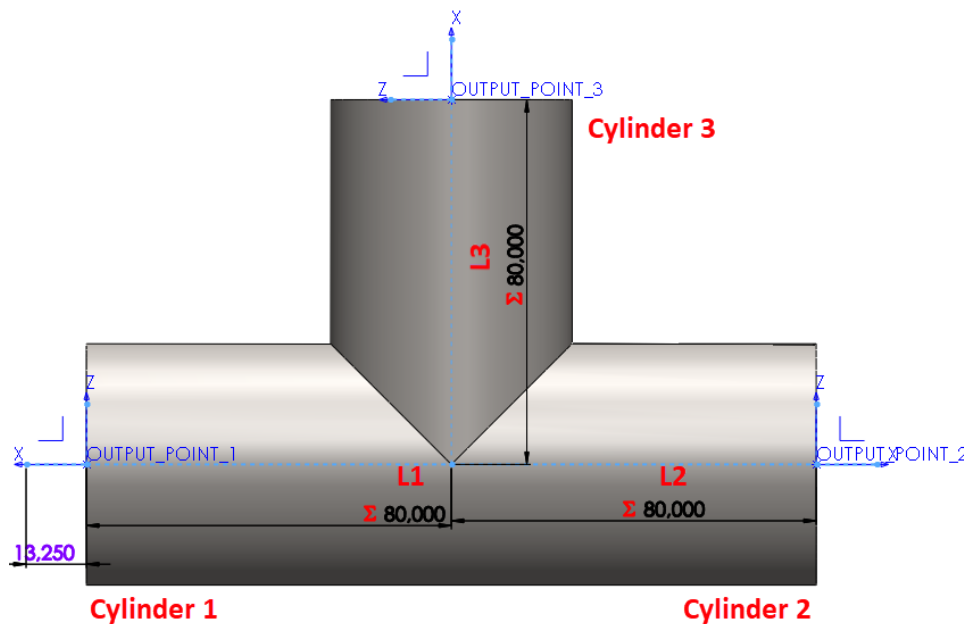

2. The 3D components require the user-defined parameters **Lmin** and **Lmax** with appropriate values for the allowed **minimum** and **maximum length** of the respective leg/orbital cylinder.

	Property Name	Type	Value / Text Expression
1	OUTPUT_POINT_2_CSInfo	Text	IO=0 GR=0 SN=2 ET=3 SZ=DN50 OD=53,0mm WT=1,5mm C_LMIN=26,5mm C_LMAX=80,0mm
2	OUTPUT_POINT_3_CSInfo	Text	IO=0 GR=0 SN=3 ET=3 SZ=DN50 OD=53,0mm WT=1,5mm C_LMIN=26,5mm C_LMAX=80,0mm
3	OUTPUT_POINT_1_CSInfo	Text	IO=0 GR=0 SN=1 ET=3 SZ=DN50 OD=53,0mm WT=1,5mm C_LMIN=26,5mm C_LMAX=80,0mm

3. In pipe specifications with appropriately prepared 3D components (points 1 and 2), the **Allow adaption of orbital weld components** option must be activated.

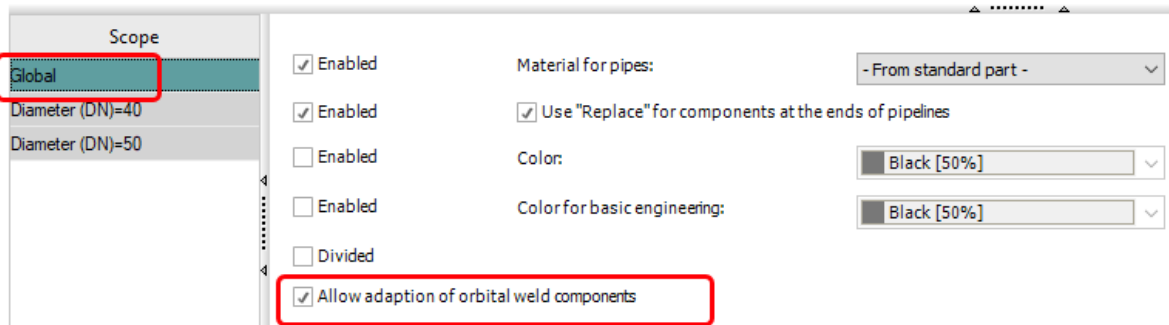

Use case 1 - Automated adjustment of an orbital welding component

1. A user selects an orbital weld component on a pipeline path and starts the new **Adapt orbital weld component** function.
 - The function checks whether the pipeline was generated with a corresponding pipe specification and whether the selected 3D component is a valid and correctly prepared orbital welding component.
2. The **Adapt component** dialog is displayed.
 - This provides a user with all the necessary information and settings that are required so that the further steps for adapting this individual 3D component can be carried out fully automatically.
 - A user must confirm/accept the entries/values in this dialog.

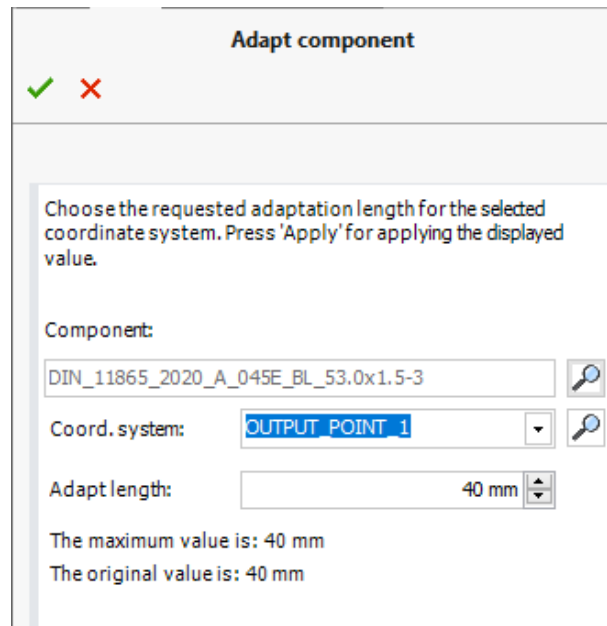

3. The automatic steps until the function is completed are:
 - The function checks whether the selected 3D file is already a copied file or still a standard part.
 - The function automatically creates an independent file copy of a standard part.
 - The function automatically replaces the default part occurrence with the copied file.
 - In the copied and replaced file, the parametric changes are made with the defined values. If the selected part is already a copied file, the parametric changes will be made directly to that file.
 - The function performs **Update** on the selected pipeline path to update the pipes on that path.

Use case 2 - Adaption of two overlapping 3D orbital welding components

1. A user performs one of the functions to generate, recalculate, edit, or update/update all pipelines on one or more pipeline paths.
 - If the new **Start component overlap design check** option was activated in the message dialog, the component overlap check is automatically carried out and the window with the result of the design check is automatically displayed.
 All overlaps found are listed and the **Adapt** button is available for each component.

Pipeline name	Component with the overlap 1			Component with the overlap 2		
path_001_ORBITAL_example	DIN_11865_2020_A_T_53.0x1.5-2		Adapt	DIN_11865_2020_A_090E_BL_53.0x1.5-1		Adapt
path_001_ORBITAL_example	DIN_11865_2020_A_090E_BL_53.0x1.5-2		Adapt	DIN_11865_2020_A_T_53.0x1.5-1		Adapt
path_001_ORBITAL_example	DIN_11865_2020_A_045E_BL_53.0x1.5-1		Adapt	DIN_11865_2020_A_090E_BL_53.0x1.5-2		Adapt
path_001_ORBITAL_example	DIN_11865_2020_A_T_53.0x1.5-4		Adapt	DIN_11865_2020_A_090E_BL_53.0x1.5-3		Adapt
path_002_ORBITAL_example	DIN_11865_2020_A_090E_BL_53.0x1.5-4		Adapt	DIN_11865_2020_A_045E_BL_53.0x1.5-4		Adapt
path_002_ORBITAL_example	DIN_11865_2020_A_T_53.0x1.5-5		Adapt	DIN_11865_2020_A_090E_BL_53.0x1.5-4		Adapt
path_003_ORBITAL_example	DIN_11865_2020_A_T_53.0x1.5-5		Adapt	DIN_11864.2_2021_A_NF_DN50-3		Adapt
path_003_ORBITAL_example	DIN_11864.2_2021_A_NF_DN50-4		Adapt	DIN_11865_2020_A_T_53.0x1.5-5		Adapt

Cancel

2. A user selects a row of overlapping components and clicks the **Adapt** button for one of them.
 - The function checks whether the components of the selected row are valid and correctly prepared orbital welding components.
 - The function calculates the overlap value of the current situation and compares it with the automatically calculated and summarized allowable adaption ranges of the two components.

3. The **Overlap resolver** dialog is displayed.

- Based on the overlap values that have already been calculated, this dialog provides a user with all the information and options necessary to eliminate the overlap and which are necessary so that all further process steps can then run fully automatically.
- A user must confirm/accept the entries/values to resolve the overlap in this dialog.

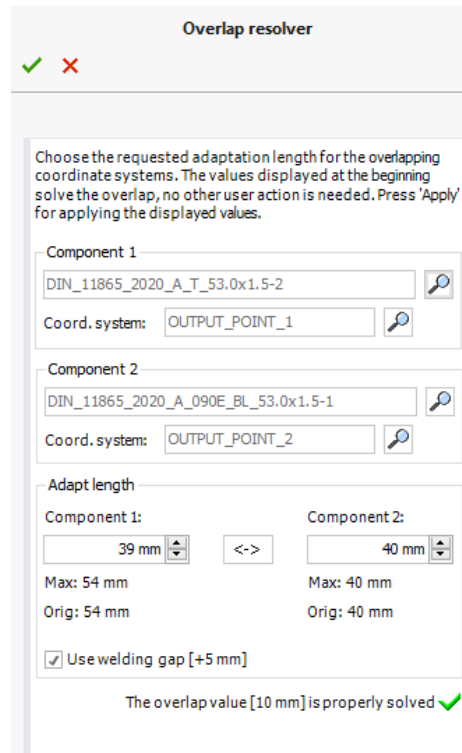

4. The automatic steps until the function is complete are:

- The function checks whether one or both 3D files are already copied files.
- The function automatically creates independent file copies of the standard parts.
- The function automatically replaces the standard part occurrences with the copied files.
- In the copied and replaced files, the parametric changes are automatically made with the defined values.
If one or both parts are already copied and adapted files, the parametric changes are made directly in these files.
- After the adaption process, the function automatically performs the component overlap check again.
- The **Component overlap check result** window automatically reappears so that a user can directly start the next adaption run for a next row of overlapping components from this dialog.

Enhancement in the Transfer connection properties function

In Piping 2023 we introduced the **Transfer connection properties** function. With version 2024, this has now been significantly enhanced.

In addition to the previously available file properties (standard or custom) of external parts/assemblies, Piping can now also read all existing virtual characteristics from them and write them to the respective last component within the pipeline assembly.

Nothing has changed in terms of handling and the process; it is still as follows:

- For selected pipeline paths, the function is started from the context menu.
- A window with a progress bar shows the steps taking place.
- First, any existing old connection information is deleted from the paths/parts within the active assembly.
- Then the function searches for the selected pipeline paths for the external assemblies/components to which the 3D sketch lines of the paths with relationships/mates are connected.
- If an external component found meets the basic requirement, all available file properties and now new also the existing virtual characteristics are read.
- In the pipeline assembly, this read information is then written to the "last" component placed there as virtual characteristics with the prefix **OE_** for each connected line/**path end**.
- These steps are performed for each selected pipeline path and its path ends where the 3D sketch lines are connected to external components.

All transferred connection properties are then displayed as virtual characteristics in the VC info window of the Piping application, as well as in the structure tree (Step 2) of Smapp3D Isometric.

Using appropriate Isometric mappings and rules, you can bring this information to Isogen and the Isometric drawing.

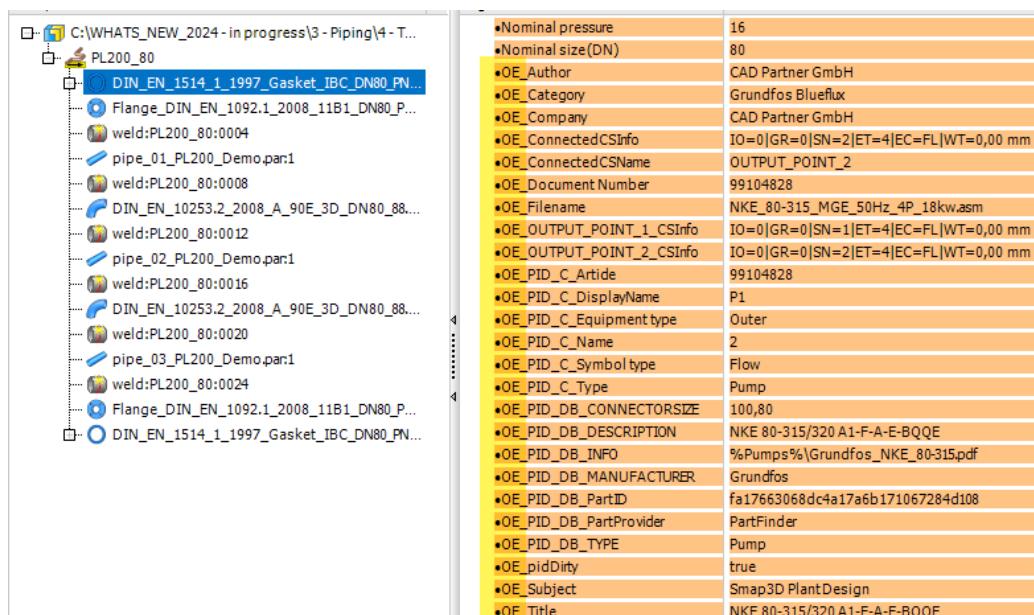
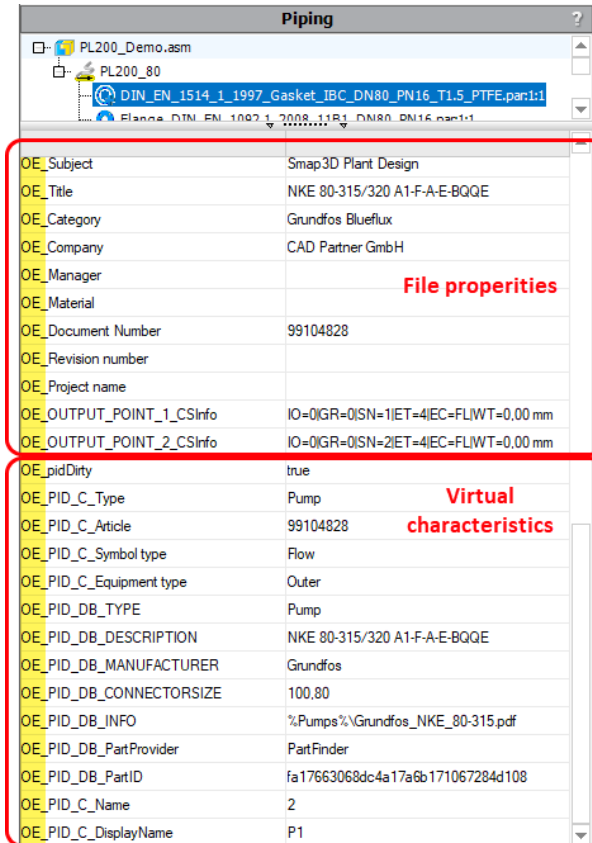

The VC info windows in the windows of the Piping and P&ID To-Do list application remember the last state

Previously, every time the Piping and P&ID To-Do List application was restarted, the respective VC information windows (shows the virtual characteristics of a selected object for the respective application) was loaded within the application window in the opened (visible) state.

For all users who did not want to actively work with these windows, this meant they had to repeatedly close/collapse the VC info window(s) with one click.

As of version 2024, the applications now remember the last state of these VC info windows (open or collapsed) and restore the last used state when the applications are restarted.

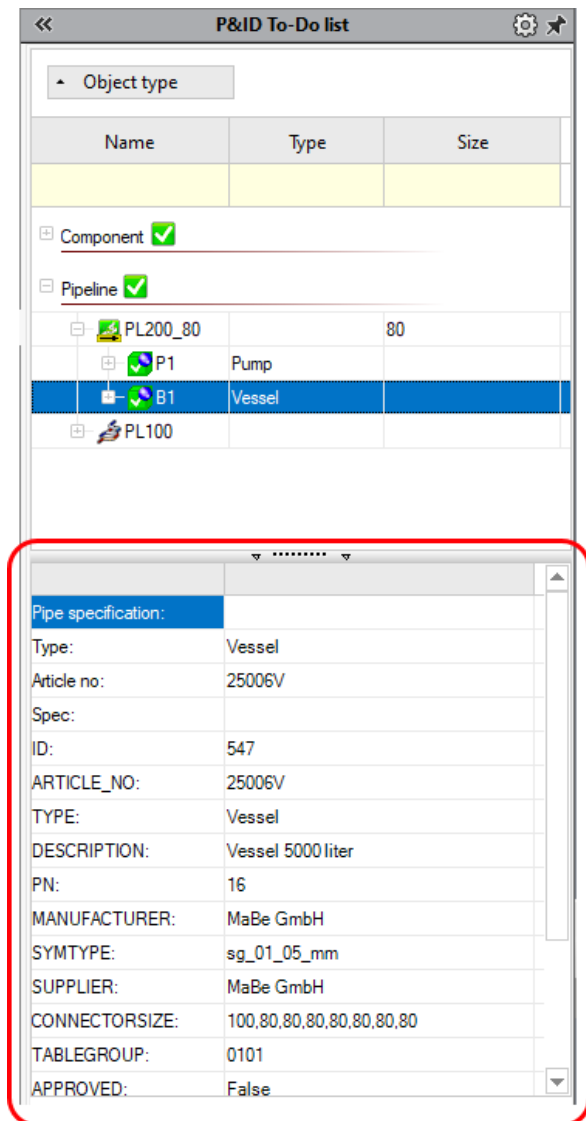
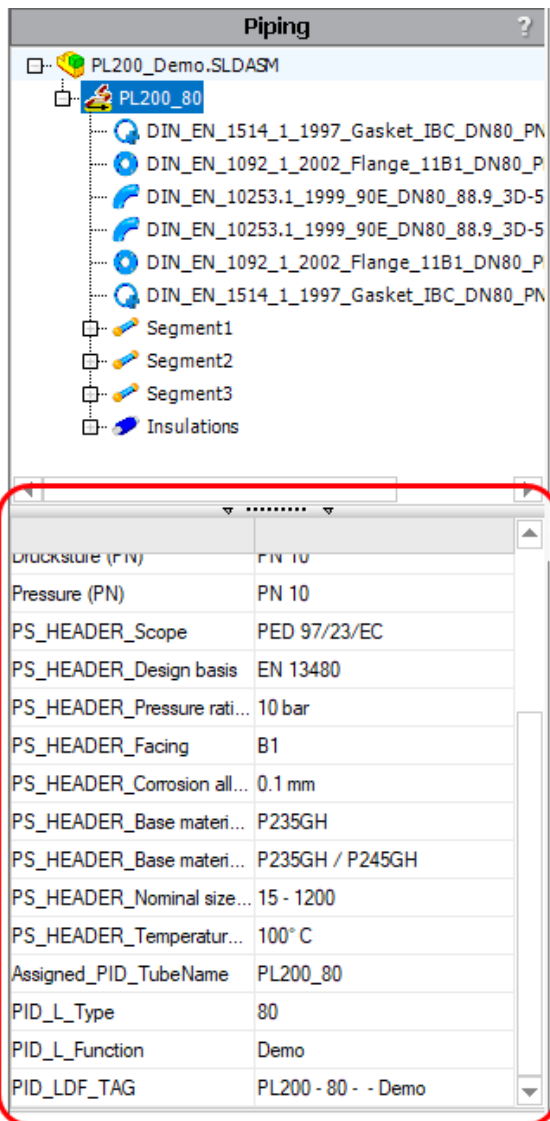

New in Smapp3D Isometric

New sub-option "Branching fittings on both drawings"

This is a new sub-option of the existing **Attempt to generate single drawing** option. Smapp3D Isometric uses this sub-option (if checked), only if the main option Attempt to generate single drawing is **NOT checked**. In all other combinations, this new sub-option has no effect.

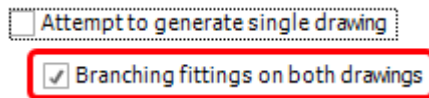

As a result of this new sub-option, existing branch fittings are shown on all isometric drawings (of the main pipeline and the branch pipeline). Without this option, branch fittings are only shown on the isometric drawing of the main pipeline.

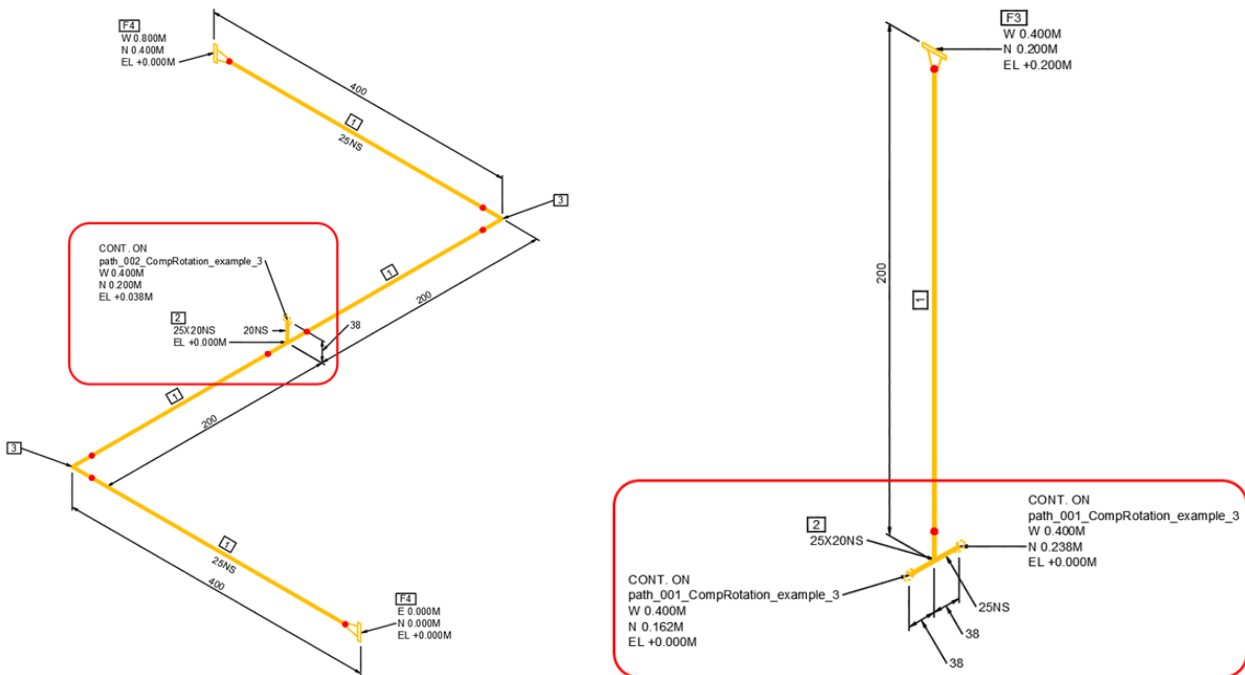



Smap3D Plant Design GmbH

Am Marktplatz 7
93152 Nittendorf
Germany

Phone.: +49 9404 9639-10

Fax: +49 9404 5209

info@smap3d.com

www.Smap3D.com

©2023 Smap3D Plant Design GmbH. All rights reserved.

These documentations respectively training materials are copyrighted works.

The copyrights belong solely to Smap3D Plant Design GmbH.

Reproduction, publication, modification, or translation - also in the form of excerpts - is not allowed without the express permission of Smap3D Plant Design GmbH.

The information in these documents is subject to change without notice

and does not constitute an obligation on the part of Smap3D Plant Design GmbH.

The content has been carefully checked.

However, Smap3D Plant Design GmbH assumes no liability for any errors or omissions.

Smapp3D is a Trademark of CAD Partner GmbH. All other names, registered trademarks and product names are used herein are the property of their respective holders.